

INTENDED FOR USE BY PROFESSIONAL EQUIPMENT OPERATORS

OPERATING INSTRUCTIONS



908 W. Main • P.O. Box 368
Laurel, MT USA 59044
800-548-7341
406-628-8231
www.WPG.com

 **READ AND UNDERSTAND BEFORE
OPERATING THIS EQUIPMENT**

APPLICABLE TO SERIAL NUMBERS 20230630
AND LATER. FOR EARLIER NUMBERS,
SEARCH WPG'S [ARCHIVE](#).



POWER FILTER 1500, AIR POWERED

Model numbers: PT1010TAIR (shown),
PT1010TAIRO, PT1410TAIRO

Original Instructions © Wood's Powr-Grip Co., Inc.





TABLE OF CONTENTS

SPECIFICATIONS	3
SAFETY	5
OPERATING FEATURES	6
ASSEMBLY	7
TO INSTALL THE CONTROL HANDLE EXTENSIONS	10
INTENDED USE	11
LOAD CHARACTERISTICS.....	11
INDIRECT LOADING	12
OPERATING ENVIRONMENT	12
DISPOSAL OF THE LIFTER	12
OPERATION	13
BEFORE USING THE LIFTER.....	13
Taking Safety Precautions	13
Performing Inspections and Tests	13
TO USE THE PAD SHUTOFFS	14
TO ATTACH THE PADS TO A LOAD	15
Generating Airflow.....	15
Positioning the Lifter on the Load.....	15
Sealing the Pads on the Load.....	16
Reading the Vacuum Gauge.....	16
TO LIFT AND MOVE THE LOAD.....	17
Interpreting the Vacuum Gauge	17
Monitoring the Vacuum Gauge.....	17
Controlling the Lifter and Load	18
In Case of a Power Failure.....	18
TO TILT THE LOAD	19
TO RELEASE THE PADS FROM THE LOAD	20
About Stand-By Mode.....	20
AFTER USING THE LIFTER.....	21
Storing the Lifter	21
Transporting the Lifter	21
INSPECTIONS AND TESTS	22

TABLE OF CONTENTS

INSPECTION SCHEDULE	22
TESTING	23
Lifter/Load Compatibility Test.....	23
Operational Tests	24
Vacuum Test.....	24
Rated Load Test.....	25
MAINTENANCE	26
VACUUM PAD MAINTENANCE.....	26
Pad-to-Load Friction Coefficient	26
Pad Inspection	26
Pad Cleaning	27
TO REPLACE SEALING RING IN VPFS10T PADS	28
REPLACEMENT PARTS.....	29
REGISTRATION AND LIMITED WARRANTY	30
TO REGISTER THIS WPG PRODUCT	30
ABOUT THE LIMITED WARRANTY	30
Obtaining Warranty Service or Repair Service.....	30

SPECIFICATIONS

Product Description	Designed for use with hoisting equipment, PT-10TAIR lifters support loads using vacuum and manipulate loads using powered 90° tilt motions.		
Model Number	PT1010TAIR	PT1010TAIRO	PT1410TAIR
Pad Spread (to outer edges)	(w/10 pads — standard)	(w/10 pads — optional)	(w/14 pads — optional)
Minimum	11¾" x 32¾" [30 cm x 83 cm]	11¾" x 32¾" [30 cm x 83 cm]	11¾" x 32¾" [30 cm x 83 cm]
Maximum	23¾" x 74¾" [60 cm x 190 cm]	33¾" x 74¾" [86 cm x 190 cm]	60¾" x 90¾" [154 cm x 230 cm]
 Maximum Load Capacity ^{1,2}	Per pad: 150 lbs [68 kg] Total: 1500 [680 kg]		
 Lifter Weight	340 lbs [155 kg]	360 lbs [163 kg]	545 lbs [247 kg]
Vacuum Pads (standard rubber ³)	10" [25 cm] nominal diameter, with ring (Model VPFS10T ⁴)		
Power Source	Compressed air, 80-150 psi [550-1035 kPa] line pressure, 11 SCFM [311 liters/minute] @ 80 psi [550 kPa]		
 Tilt Capability	Powered, 90°, continuous-duty type with adjustable-flow valves to control tilt speed; Standard speed = approx. 8 seconds per tilt travel in one direction. ⁵		
Product Options	<i>Available</i> with Control Handle Extensions. ⁶ See separate instructions about other optional features.		
 Operating Elevation	Up to 6,000' [1,828 m]		
 Operating Temperatures	32° — 104° F [0° — 40° C]		
Service Life	20,000 lifting cycles, when used and maintained as intended ⁷		
ASME Standard BTH-1	Design Category "B", Service Class "0"		
Troubleshooting Guide	TST-020_PT-AIR_REV-2017-246_2021-02-12-163436		

1..... The Maximum Load Capacity is rated at a vacuum of 16" Hg [-54 kPa] on clean, smooth, nonporous flat surfaces with a friction coefficient of 1. Pad compound, load rigidity, strength, surface conditions, overhang, angle, center of gravity and temperature can also affect the lifting capacity. A "qualified person" should evaluate the effective lifting capacity for each use (see definition under "Rated Load Test").

2. For PT1410TAIR lifters, calculated lifting capacities cannot exceed Maximum Load Capacity.

3..... Available with other rubber compounds for special purposes (see www.wpg.com).

4..... Standard with replaceable sealing rings for rough or textured surfaces (see "REPLACEMENT PARTS").

5..... Tilt speed can be adjusted as directed under "TILT COMPONENTS MAINTENANCE" in the [SERVICE MANUAL](#).

6..... While the Control Handle Extensions are optional for the PT1010TAIR(O), they are standard equipment for the PT1410TAIR. The extensions are not installed before shipping.





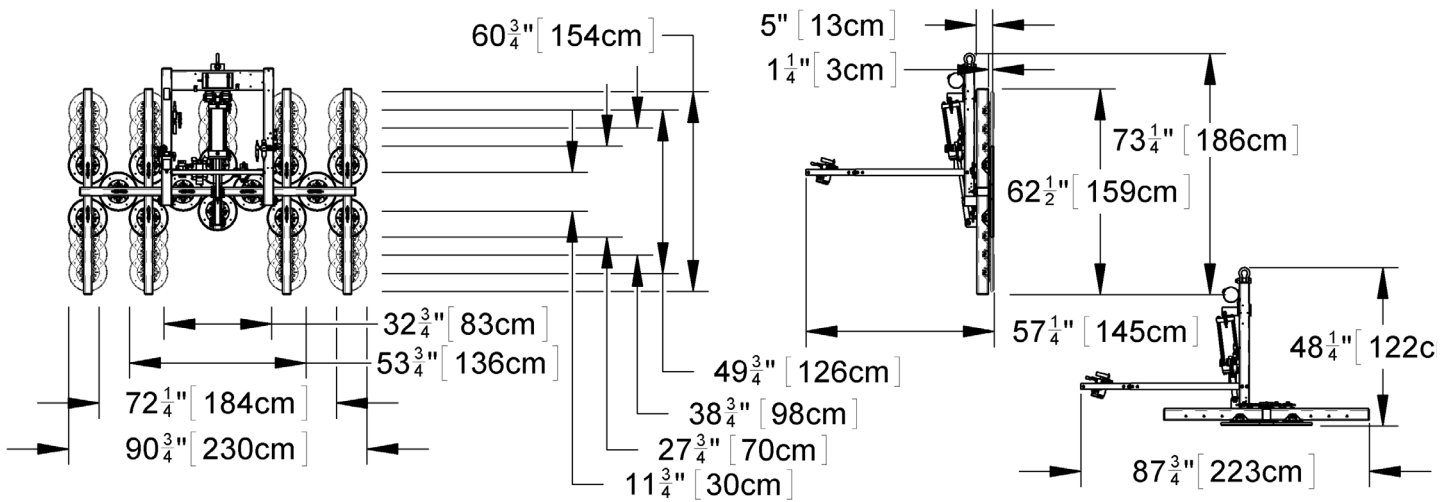
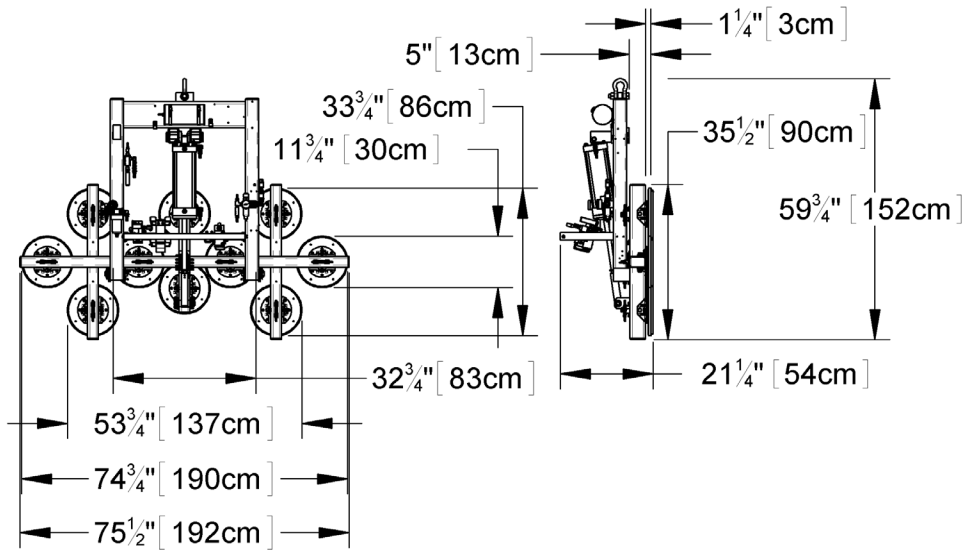
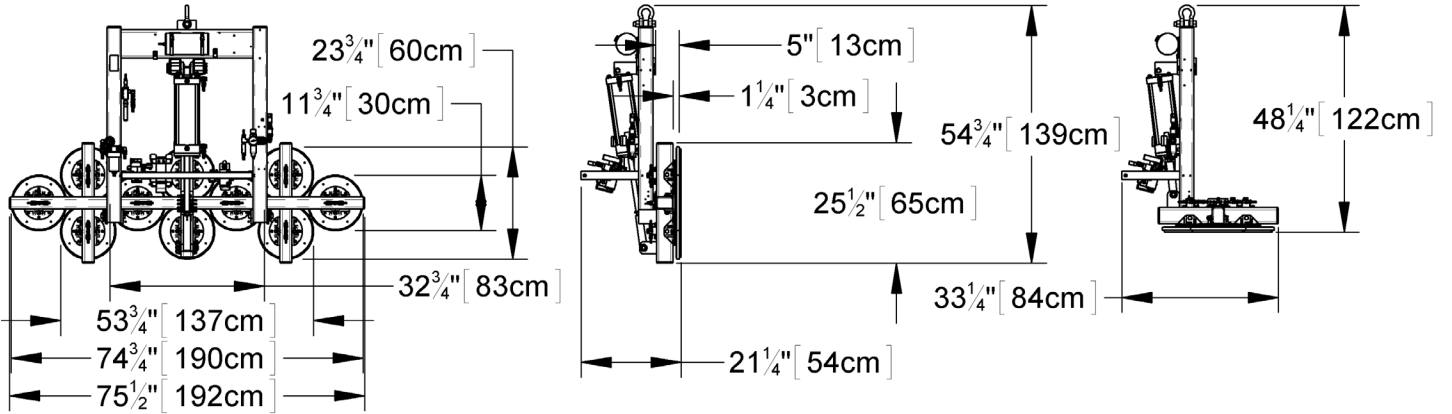















7..... Vacuum pads, filter elements and other wear-out items are excluded.

SPECIFICATIONS



Note: A standard PT1010TAIR is shown at top; a PT1010TAIRO (with pad frame option) is shown at center; a standard PT1410TAIRO (with Control Handle Extension) is shown at bottom.

SAFETY

-  Wear personal protective equipment that is appropriate for the load material. Follow trade association guidelines.
-  Do not remove or obscure safety labels.
-  Do not make any modifications to the lifter (see “LIMITED WARRANTY”).
-  Use the lifter only in an approved “OPERATING ENVIRONMENT” (see “INTENDED USE”).
-  Make sure to consider all possible effects of “INDIRECT LOADING” on lifting capacity (see “INTENDED USE”).
-  Do not use a lifter that is damaged, malfunctioning, or missing parts.
-  Do not use a lifter if the sealing edge of any vacuum pad is cut or otherwise damaged.
-  Do not use a lifter to lift cracked or broken glass.
-   Do not exceed the Maximum Load Capacity or lift loads the lifter is not designed for (see “INTENDED USE”).
-   Do not use a lifter if the Maximum Load Capacity or any safety label appears to be missing or obscured.
-  Make sure the contact surfaces of the load and vacuum pads are clean before attaching the lifter (see “MAINTENANCE”).
-  Position the vacuum pads correctly on the load before lifting (see “OPERATION”).
-  Do not lift a load if any vacuum indicator shows inadequate vacuum.
-  Keep unauthorized personnel away from the lifter, to avoid injury in case of an unintended load release.
-  Do not touch the vacuum release controls during a lift.
-  Do not allow people to ride on the lifter or the load.
-  Do not lift a load higher than necessary or leave suspended loads unattended.
-  Do not position a loaded or unloaded lifter over people.
-  Before servicing a powered lifter, place the power control in the inactive position and, when possible, disconnect the power source.

OPERATING FEATURES

Features shown here are underlined> on their first appearance in each section following.

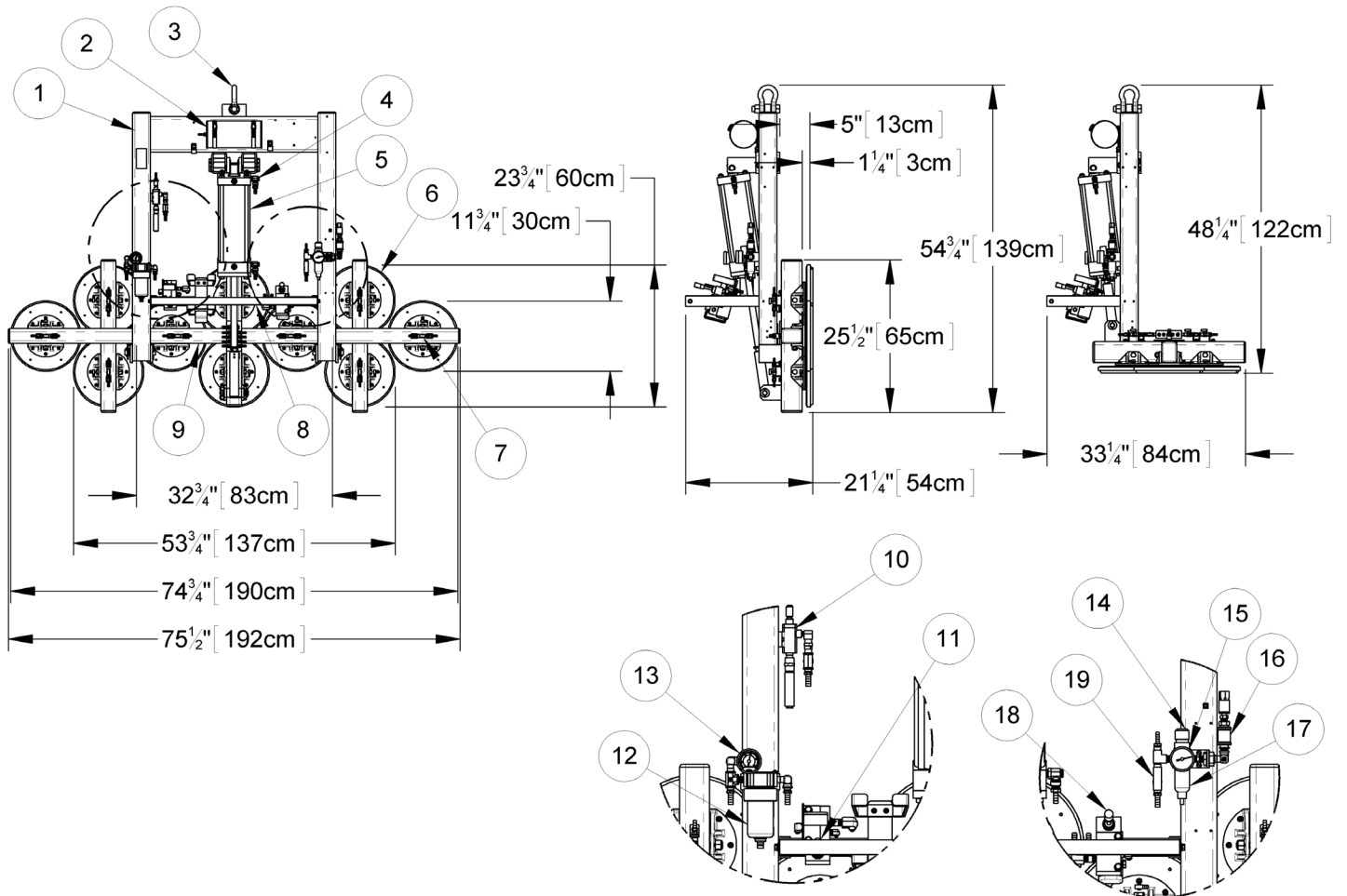

- | | | |
|--------------------------|----------------------------------|----------------------------------|
| 1 LIFT BAR | 2 VACUUM RESERVE TANK | 3 LIFT POINT |
| 4 TILT SPEED VALVE | 5 TILT ACTUATOR | 6 VACUUM PAD |
| 7 PAD SHUTOFF | 8 CONTROL HANDLE | 9 PAD FRAME |
| 10 VACUUM PUMP (venturi) | 11 VACUUM CONTROL VALVE | 12 AIR FILTER — 4.4 OZ BOWL SIZE |
| 13 VACUUM GAUGE | 14 AIR PRESSURE REGULATOR | 15 PRESSURE GAUGE |
| 16 AIR SUPPLY VALVE | 17 AIR FILTER — 1.0 OZ BOWL SIZE | 18 TILT CONTROL VALVE |
| 19 TILT MASTER VALVE | | |

Note: A standard PT1010TAIR is shown. Although some of the following photos do not show this specific lifter, they all illustrate how this kind of lifter functions.

For information about specific parts, see ["REPLACEMENT PARTS"](#) and/or any separate instructions for Product Options.

ASSEMBLY

- 1) Remove all shipping materials and save them with the shipping container for future use.
- 2) Select a crane and/or hoist rated for the Maximum Load Capacity plus the Lifter Weight.

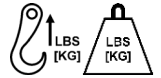

Note: Any lifter use must comply with all statutory or regulatory standards for hoisting equipment in your region.

- 3) Raise the lift bar to fully vertical (figs. 3A-B): Engage the tilt actuator (see “[TO TILT THE LOAD](#)”) and manually lift the bar at the same time.

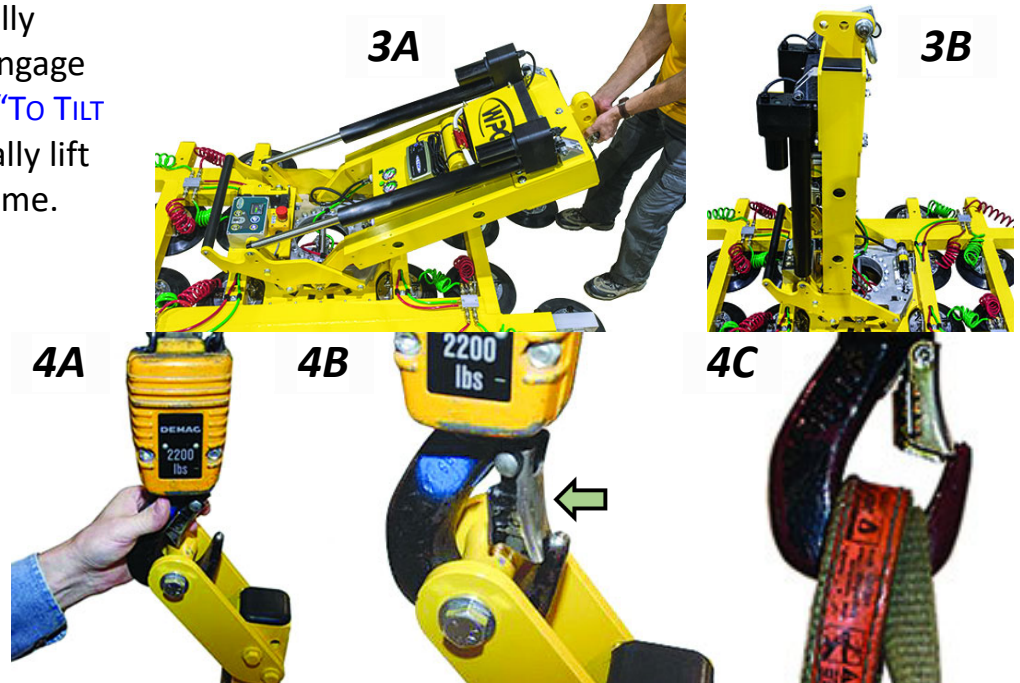

! **Make sure hook has restraining latch (arrow in fig. 4B).**

Note: Use rigging as needed to make sure the hook does not interfere with the load (fig. 4C).

! **Only use rigging rated for Maximum Load Capacity plus Lifter Weight.**

- 5) Use the hoisting equipment to remove the lifter from the shipping container. Avoid damaging the vacuum pads.
- 6) Remove the pad covers (fig. 6A) and save them for future use.



ASSEMBLY

- 7) Connect the lifter to an appropriate compressed air supply (see Power Source under “SPECIFICATIONS”):

Note: Qualified service personnel should install the female quick connector (supplied) on the compressed air line.



This installation should be performed by qualified service personnel.

Caution: Make sure the air line is routed so that it does not become tangled or damaged during operation.

- 7.1) Connect the female quick connector to the male quick connector (figs. 7A-C).



- 7.2) Place the air supply valve in the “on” position (| — fig. 7D).

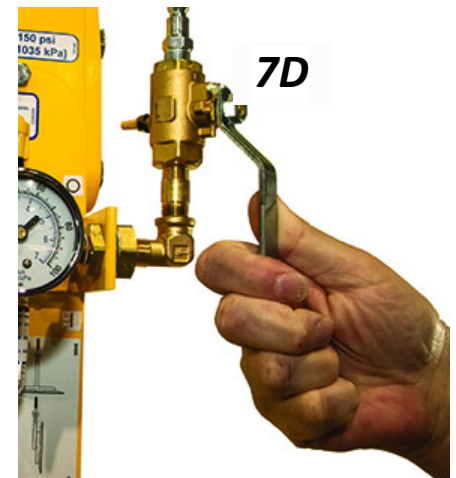

- 7.3) With the lifter suspended, place the lever on the vacuum control valve in the “attach” position (| ← — see “Sealing the Pads on the Load”).

ASSEMBLY

- 7.4) Adjust the air pressure regulator to supply 80 psi [550 kPa]:¹ Pull up the adjustment collar on top of the regulator. Turn the collar clockwise to increase pressure or counter-clockwise to decrease pressure (fig. 7E).

When the pressure gauge registers a minimum air pressure of 80 psi [550 kPa], push down the collar to lock it in place.



- 7.5) Place the lever on the vacuum control valve in the center position (see “About Stand-By Mode”).

Note: Place the air supply valve in the “off” position (○ — fig. 7F) when the lifter is not in use; otherwise, the air compressor will cycle frequently.



- 8) Perform tests as required under “TESTING”.

1..... Exceeding this pressure consumes more air and does not improve lifter performance.

ASSEMBLY

TO INSTALL THE CONTROL HANDLE EXTENSIONS

When applicable, install the Control Handle Extensions using the parts supplied:

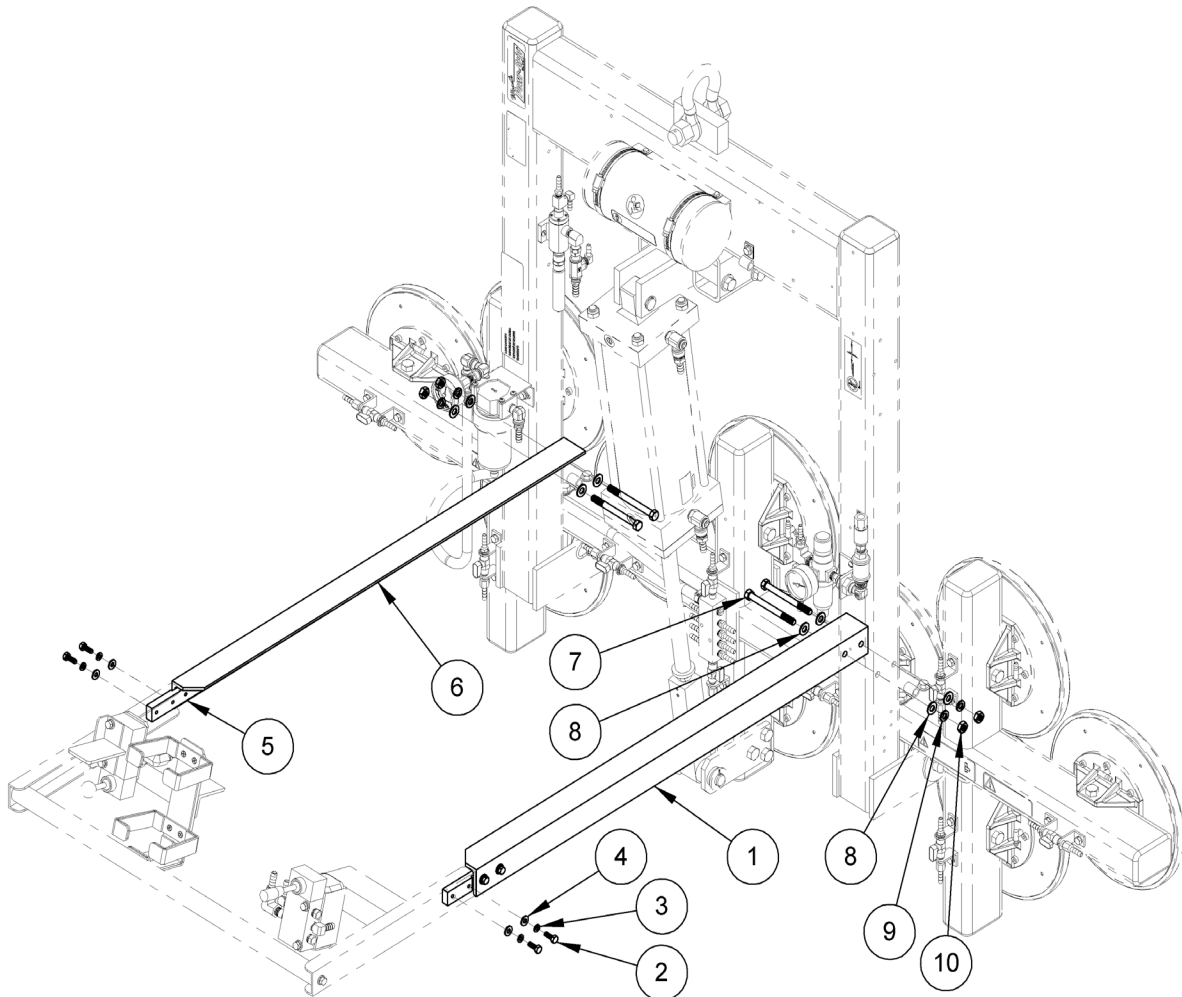

- | | | | |
|---|------------------------------------|----|-------------------------------|
| 1 | RIGHT CONTROL HANDLE EXTENSION | 2 | 1/4-20 X 3/4" HEXHEAD SCREW |
| 3 | 1/4" SPLIT LOCK WASHER | 4 | 1/4" SAE FLAT WASHER |
| 5 | CONTROL HANDLE EXTENSION CONNECTOR | 6 | LEFT CONTROL HANDLE EXTENSION |
| 7 | 3/8-16 X 4" HEX HEAD CAP SCREW | 8 | 3/8" SAE FLAT WASHER |
| 9 | 3/8" LOCK WASHER | 10 | 3/8-16 MACHINE SCREW HEX NUT |

Not shown: 3/8" ID x 5/8 OD VACUUM HOSE — CLEAR
1/4" ID x 3/8" OD VACUUM HOSE — RED

INTENDED USE

LOAD CHARACTERISTICS

Make sure the vacuum lifter is intended to handle each load according to these requirements:



Do NOT lift explosives, radioactive substances or other hazardous materials.



- The load weight must not exceed the Maximum Load Capacity.
- The load must be a single piece of relatively nonporous material with a flat and relatively smooth contact surface.^{1, 2} To determine whether the load is too porous or rough, perform the “[Lifter/Load Compatibility Test](#)”.
- The load's contact surface must be able to obtain a friction coefficient of 1 with the lifter's vacuum pads (see “[Pad-to-Load Friction Coefficient](#)”). Otherwise, the capacity should be derated appropriately.
- The load's surface temperature must not exceed the Operating Temperatures.³
- The load's *minimum* length and width are determined by the current Pad Spread (see “SPECIFICATIONS”).
- The load's *maximum* length and width are determined by its allowable overhang.⁴
- 1¼" [3 cm] is the allowable thickness at Maximum Load Capacity.⁵



Note: Standard vacuum pads can stain or deform load surfaces with light colors or soft coatings. Test such surfaces for damaging effects before using the lifter on them.⁶

1..... Although concave vacuum pads can also attach to some curved loads, curvature can reduce lifting capacity. Contact WPG for more information.

2..... A “single piece” of material includes curtainwall assemblies, unitized glazing systems and similar construction units.

3..... Vacuum pads made from a heat-resistant rubber compound can enable you to lift loads with higher surface temperatures. Contact WPG or an authorized dealer for more information.

4..... The allowable overhang is the amount of load material that can extend sideways beyond the vacuum pads without breaking or otherwise being damaged. This depends on the load material, its thickness, and the angle of handling (if any). Since every material has different physical properties, the allowable overhang must be evaluated separately for each load type. Contact WPG or an authorized dealer for more information.

5..... However, the allowable thickness increases as load weight decreases. Contact WPG for more information.

6..... Alternative rubber compounds are available for these purposes. Contact WPG or an authorized dealer for more information.

INTENDED USE

INDIRECT LOADING

Make sure to account for dynamic loading or other inadvertent loading that can negatively affect lifting capacity, such as:

- Weight amplification that results when a loaded vacuum lifter abruptly starts/stops moving, changes direction or bounces up and down (eg, when a telehandler transports a loaded lifter across rough terrain).
- External force that effectively increases the weight of a lifter's attached load (eg, when a load of sheet material reacts to wind gusts).



Indirect loading can reduce lifting capacity.

OPERATING ENVIRONMENT

Make sure the lifter is suitable for each work environment, given the following restrictions:

- This lifter is not intended for any environment that is dangerous to the operator or damaging to the lifter. Avoid environments containing explosives, caustic chemicals and other dangerous substances.
- The work environment is limited by the Operating Elevation and Operating Temperatures.^{1, 2}
- The lifter is not designed to be watertight. Do not use it in rain or other unsuitable conditions.



Never use lifter in dangerous environments.

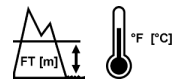

Moisture can reduce lifting capacity.

CE/UKCA — A secondary positive holding device is required to lift loads on construction sites.

DISPOSAL OF THE LIFTER

After the Service Life of the lifter has ended (see “SPECIFICATIONS”), dispose of it in compliance with all local codes and applicable regulatory standards.

1..... Although lifter use may be possible at higher elevation, lifting capacity is reduced whenever the lifter is unable to attain vacuum in the green range on the vacuum gauge. Contact WPG for more information.

2..... Special provisions may allow the lifter to operate outside the specified temperature range. Contact WPG for more information.

BEFORE USING THE LIFTER

Determine whether the vacuum lifter is capable of each intended task (see “SPECIFICATIONS” and “[INTENDED USE](#)”). Then complete the following preparations:

Taking Safety Precautions

- Be trained in all industry and regulatory standards for lifter operation in your region.
- Follow trade association guidelines about precautions needed for each load material.



Read all directions and safety rules before using lifter.



Always wear appropriate personal protective equipment.

Performing Inspections and Tests

- Follow the “[INSPECTION SCHEDULE](#)” and “[TESTING](#)”.
- Service each air filter whenever its bowl contains liquid or other contaminants or its element appears dirty (see “AIR FILTER MAINTENANCE” in [SERVICE MANUAL](#)).



Examine air filters regularly and service when needed.

TO USE THE PAD SHUTOFFS

Each pad shutoff on the pad frame controls the vacuum line to the adjacent vacuum pad. Activating or deactivating the airflow at specific pads enables the lifter to handle loads with different weights and dimensions (see “SPECIFICATIONS”) or to avoid holes in the load surface.

To support the maximum load weight and larger load dimensions, all pads must be activated; for smaller weights and dimensions, some pads may be deactivated, **provided that the lifter still has sufficient capacity to support the load** (see “LOAD CHARACTERISTICS”).



Closing any pad shutoff reduces lifting capacity.

To activate a pad, open the shutoff valve (ie, place lever *parallel* with vacuum line — fig. 1A).



To deactivate a pad, close the shutoff valve (ie, place lever *perpendicular* to vacuum line — fig. 1B).



To calculate the lifting capacity when some pads are deactivated, consult the Per-Pad Load Capacity and multiply by the number of pads currently activated. Always activate pads in a symmetrical configuration and use as many pads as possible for each load being lifted, to maximize lifting capacity and to minimize load overhang.



OPERATION

TO ATTACH THE PADS TO A LOAD

Generating Airflow

Make sure the lever on the vacuum control valve is in stand-by mode: Simultaneously press the button (fig. 1A) and turn the lever to the center position. (fig. 1B).

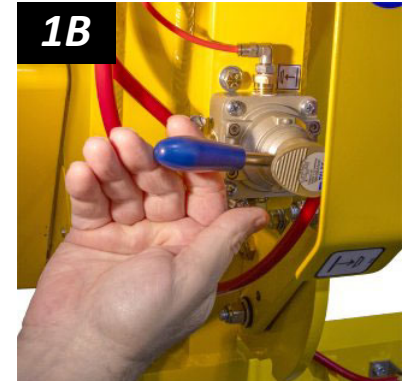
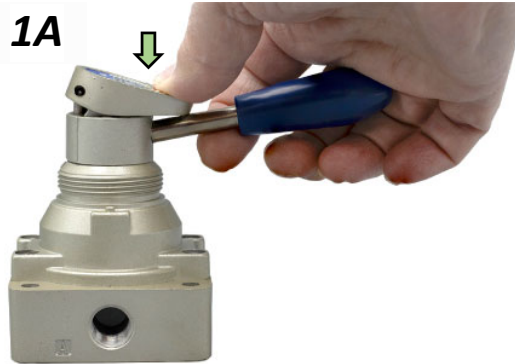

Place the air supply valve in the “on” position (| — see “ASSEMBLY”). Any interruption of airflow during lifter operation could result in an unintentional load release and personal injury.

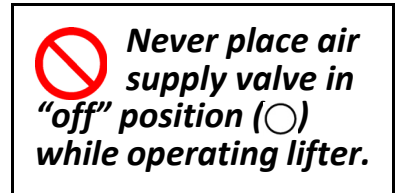

Positioning the Lifter on the Load

1) Make sure the contact surfaces of the load and vacuum pads are clean (fig. 1C — see “Pad Cleaning”).



2) Center the pad frame on the load (fig. 2C).¹



3) Make sure all vacuum pads will fit on the load and will be loaded evenly (fig. 3C).

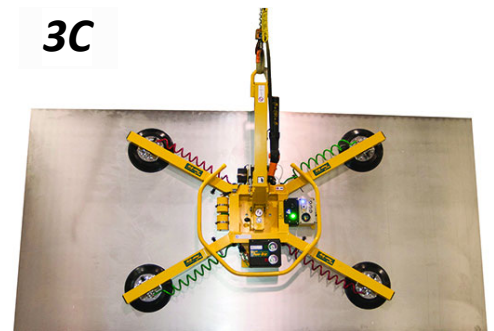

Consult the Per-Pad Load Capacity.

4) Place the vacuum pads in contact with the load surface.

1..... The lifter is designed to handle the maximum load weight when its center of gravity is positioned within 2" [5 cm] of the pad frame's center point. Uncentered loads can damage the lifter.

OPERATION

Sealing the Pads on the Load

- 1) Place the lever on the vacuum control valve in the “attach” position (↵←): Simultaneously press the valve’s button and turn the lever counterclockwise (fig. 1A and inset). This draws air immediately at the vacuum pads.¹



Any interruption of airflow during lifter operation could result in an unintentional load release and personal injury.



Keep valve lever in “attach” position (↵←) throughout lift.

- 2) Make sure the vacuum pads seal completely against the load.²

Reading the Vacuum Gauge

A vacuum gauge shows the current vacuum level in positive inches of Hg and negative kPa:

- Green range (≥ 16 " Hg [-54 kPa]): Vacuum level is sufficient to lift the maximum load weight (fig. 1B).
- Red range (< 16 " Hg [-54 kPa]): Vacuum level is **not** sufficient to lift the maximum load weight (fig. 1C).

If it takes more than 5 seconds for the vacuum level to reach 5" Hg [-17 kPa], press on any vacuum pad that has not yet sealed.

Once the pads have sealed, the lifter should be able to maintain sufficient vacuum for lifting, except when used above the maximum Operating Elevation.³ If it does not, perform the “Vacuum Test”.



1..... Do not place the valve lever in the “attach” position until the pads are contacting the load.

2..... Although a vacuum pad may become distorted during shipping or storage, this condition should correct itself with continued use.

3..... If the lifter is used above the maximum Operating Elevation (see “SPECIFICATIONS”), it may not be able to maintain sufficient vacuum for lifting. Contact WPG for more information.

OPERATION

TO LIFT AND MOVE THE LOAD



Lift bar must be vertical to lift load.

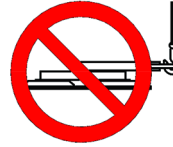
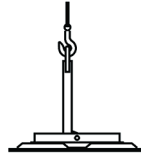

Interpreting the Vacuum Gauge



Vacuum is sufficient to lift the Maximum Load Capacity whenever the vacuum gauge registers in the green range.



Never lift load unless vacuum gauge registers in the green range, because premature lifting could result in load release and personal injury.

Monitoring the Vacuum Gauge

Monitor the vacuum gauge (fig. 1B) throughout the entire lift.



Make sure the vacuum gauge remains completely visible.

The vacuum pump runs continuously to maintain sufficient vacuum for lifting the maximum load weight.

However, if the ***vacuum gauge shows a level less than 16" Hg [-54 kPa]:***

- 1) Keep everyone away from a suspended load until it can be safely lowered to a stable support.
- 2) Stop using the lifter until the cause of the vacuum loss can be identified: Conduct the “[Pad Inspection](#)” and perform the “[Vacuum Test](#)”.
- 3) Correct any faults before resuming normal operation of the lifter.



Stay clear of any suspended load while gauge warns of insufficient vacuum.



OPERATION

Controlling the Lifter and Load

When the lifter is ready, use the hoisting equipment to raise the lifter and load as needed.

Use a control handle (circled in fig. 1A) to keep the lifter and load in the required position.¹

Once there is enough clearance, you may move the load as required.

Note: The hang angle of the lifter may shift suddenly upon lifting or releasing the load. The operator should anticipate and compensate for such changes.



Never allow any pad shutoff to be opened or closed while lifting, because this could result in a load release and personal injury.

In Case of a Power Failure

Although the lifter is designed to support the load for at least 5 minutes without power, this depends on many factors, including the [“LOAD CHARACTERISTICS”](#) and the condition of the vacuum pads (see [“VACUUM PAD MAINTENANCE”](#)).

If a power failure occurs, keep everyone away from a suspended load until it can be safely lowered to a stable support. Correct any faults before resuming normal operation of the lifter.



Stay clear of any suspended load during power failure.

1..... If the lifter has Control Handle Extensions, do not use them to correct the hang angle of a fully loaded lifter. They are not designed to sustain more than 100 lbs [45.5 kg] of force.

OPERATION

TO TILT THE LOAD



Make sure load is positioned correctly on lifter (as previously directed).

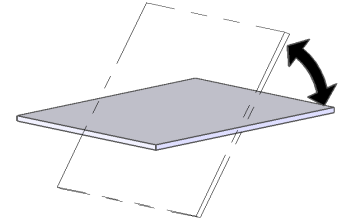

Caution: Unbalanced loads can interfere with the lifter's tilt capability.

- 1) Make sure the load has enough clearance to tilt without contacting anyone or anything.
- 2) Use the tilt control valve to tilt the load as required:

- To move the load towards the *flat* position (fig. 2A), push the valve lever *upward* (fig. 2A inset).

Note: Release the lever to stop the load in the current position.

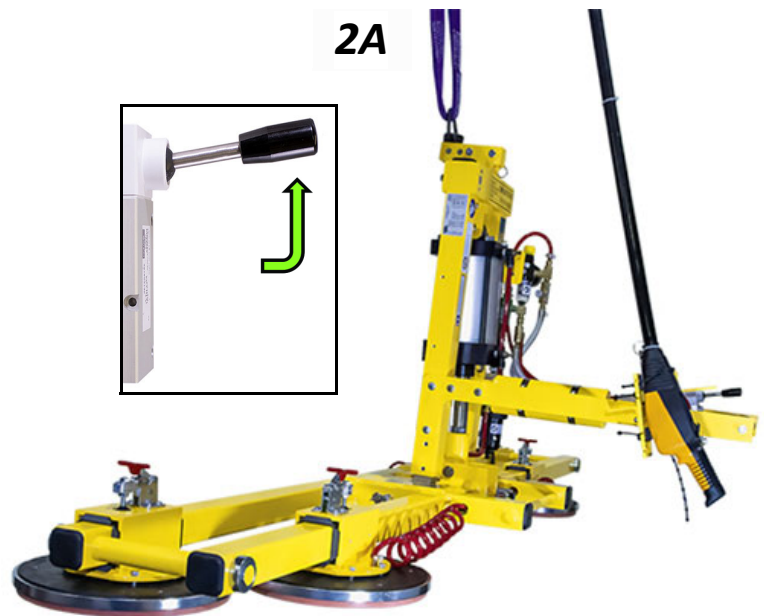

- To move the load towards the *upright* position (fig. 2B), push the valve lever *downward* (fig. 2B inset).

Note: Release the lever to stop the load in the current position.

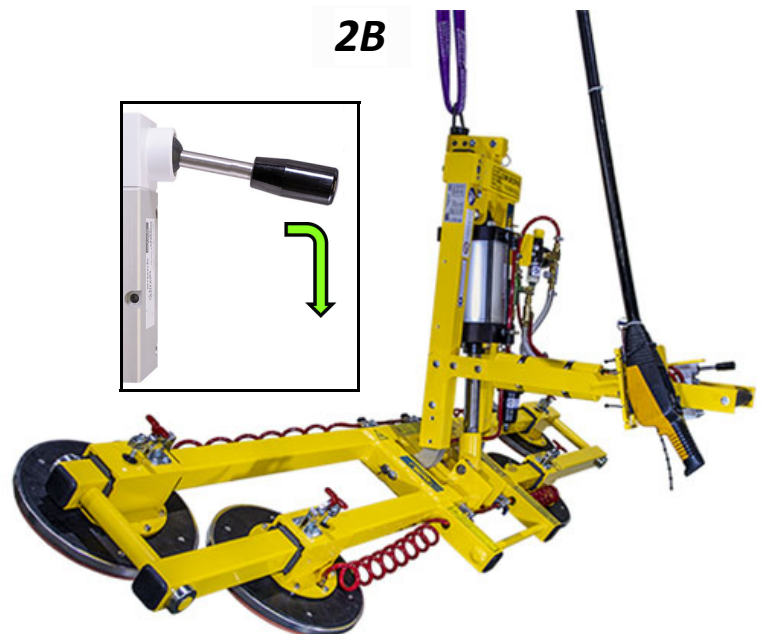

Note: See "LOAD CHARACTERISTICS" for information about allowable overhang.

OPERATION

TO RELEASE THE PADS FROM THE LOAD



Make sure load is at rest and fully supported before releasing vacuum pads.

- 1) Move the lever on the vacuum control valve to the “release” position (|→>): Simultaneously press the control valve’s button and turn the lever clockwise (fig. 1A and inset). This breaks the vacuum seal.

1A

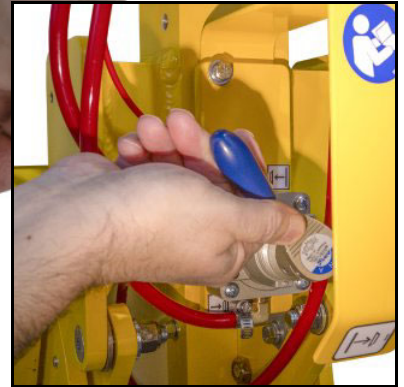

Do not move lifter until pads release completely, because such movement could result in load damage or personal injury.

- 2) After the load is successfully released, move the lifter away.
- 3) Place the lifter in stand-by mode (see below).
- 4) Before you lift another load, perform the Every-Lift Inspection (see “[INSPECTION SCHEDULE](#)”).

About Stand-By Mode

Move the lever on the vacuum control valve to the center position (fig. 1B).



Never move valve lever to center position while lifting load, because this could result in load release and personal injury.



AFTER USING THE LIFTER

- 1) Place the air supply valve in the “off” position (○).
- 2) Use the hoisting equipment to lower the vacuum lifter gently onto a stable support. Then detach the hoisting hook from the lift point.

Caution: Do not set lifter on surfaces that could soil or damage vacuum pads.

Note: Parking feet (circled in fig. 2A) on the pad frame can be used to support an unloaded lifter when not suspended. Make sure the lifter leans securely against an appropriate support that does not contact the vacuum pads.

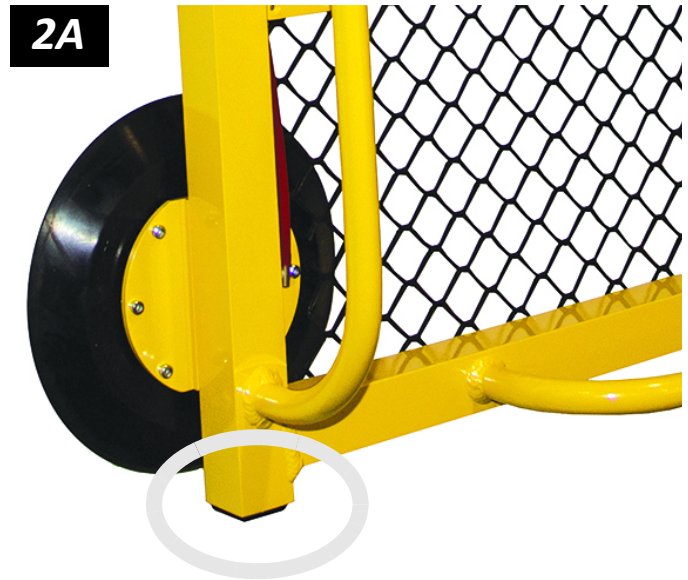

Storing the Lifter

- 1) Disconnect the compressed air supply (see “ASSEMBLY”).
- 2) Use the covers supplied to keep the vacuum pads clean (fig. 1A).

CE/UKCA — To prevent the lifter from tipping over on relatively horizontal surfaces, place the vacuum pads facedown on a clean, smooth, flat surface.

- 3) Store the vacuum lifter in a clean, dry location.



Transporting the Lifter

Secure the lifter in the original shipping container with the original shipping materials or equivalent.

INSPECTIONS AND TESTS

INSPECTION SCHEDULE

Perform inspections according to the following frequency schedule. If any fault is found, correct it and perform the next most frequent inspection before using the vacuum lifter.

Note: If a lifter is used less than 1 day in a 2-week period, perform the Periodic Inspection before using it.

Action	Every Lift	Frequent ¹ (every 20-40 hrs)	Periodic ² (every 250-400 hrs)
Examine <u>vacuum pads</u> for contaminants or damage (see “Pad Inspection”).	✓	✓	✓
Examine load surface for contaminants or debris.	✓	✓	✓
Examine controls and indicators for damage.	✓	✓	✓
Examine lifter’s structure for damage.		✓	✓
Examine vacuum system for damage (including <u>vacuum pads</u> , fittings and hoses).		✓	✓
Examine <u>air filters</u> for conditions requiring service (see “AIR FILTER MAINTENANCE” in SERVICE MANUAL).		✓	✓
Perform “Vacuum Test” .		✓	✓
Check for unusual vibrations or noises while operating lifter.		✓	✓
Examine entire lifter for evidence of: <ul style="list-style-type: none"> • looseness, excessive wear or excessive corrosion • deformation, cracks, dents to structural or functional components • cuts in vacuum pads or hoses • any other hazardous conditions 			✓

1..... The Frequent Inspection is also required whenever the lifter has been out of service for 1 month or more.

2..... The Periodic Inspection is also required whenever the lifter has been out of service for 1 year or more. Keep a written record of all Periodic Inspections. If necessary, return the lifter to WPG or an authorized dealer for repair (see [“REGISTRATION AND LIMITED WARRANTY”](#)).

TESTING

Perform the following test to determine whether or not a load surface is too porous or rough:

Lifter/Load Compatibility Test¹

- 1) Make sure the vacuum generating system is functioning correctly (see “[Vacuum Test](#)”).
- 2) Thoroughly clean the load surface and the vacuum pads (see “[Pad Cleaning](#)”).
- 3) Place the load in the upright position on a stable support.
- 4) Attach the vacuum pads to the load as previously directed.
- 5) After the vacuum level appears in the green range on the vacuum gauge, place the air supply valve in the “off” position (○).
- 6) Raise the load a minimal distance, to make sure it is supported by the lifter.
- 7) Watch the vacuum gauge: **Starting from a vacuum level of 16" Hg [-54 kPa], the lifter must maintain a vacuum level greater than 12" Hg [-41 kPa] for 5 minutes.**² If not, lifting this load requires additional precautions (eg, a load sling). Contact WPG for more information.
- 8) Lower the load *after* 5 minutes or *before* the vacuum level diminishes to 12" Hg [-41 kPa].



Take precautions in case load should fall during test.

1..... The “[Pad-to-Load Friction Coefficient](#)” can affect the outcome of this test.

2..... Under CE and UKCA requirements, the lifter must maintain a vacuum level **greater than 8" [-27 kPa]**.

INSPECTIONS AND TESTS

Perform the following tests before placing the lifter in service *initially, following any repair,* when directed in the “*INSPECTION SCHEDULE*”, or *whenever necessary*:

Operational Tests

Test all features and functions of the lifter (see “OPERATING FEATURES” and “OPERATION”).

Vacuum Test

- 1) Clean the faces of the vacuum pads (see “*Pad Cleaning*”).
- 2) Use a test load with weight equal to the Maximum Load Capacity, a clean, smooth, nonporous surface and other appropriate “*LOAD CHARACTERISTICS*”.¹
- 3) Attach the lifter to the test load as previously directed.



- 4) After the vacuum level appears in the green range on the vacuum gauge, raise the load a minimal distance and place the air supply valve in the “off” position (○).



Take precautions in case load should fall during test.

- 5) Watch the vacuum gauge: *The vacuum level should not decrease by more than 4" Hg [-14 kPa] in 5 minutes.*

- 6) Lower the load after 5 minutes or whenever a lifter fails the test, and release the load as previously directed.



Never use lifter that has failed test.

- 7) Qualified service personnel must correct any fault in the vacuum system before returning the lifter to service.



This service must be performed by qualified service personnel.

1..... The load should have either a flat surface or no more curvature than the lifter is designed for, if any.

INSPECTIONS AND TESTS

Rated Load Test¹

The following steps must be performed or supervised by a qualified person:²

- 1) Use a test load that weighs 125% ($\pm 5\%$) of the Maximum Load Capacity and has the appropriate “LOAD CHARACTERISTICS”. 
- 2) Attach the vacuum pads to the load as previously directed.
- 3) Position the load to produce the greatest stress on the lifter consistent with “INTENDED USE”.
- 4) Raise the load a minimal distance and leave it suspended for 2 minutes.
- 5) Once the test is completed, lower the load for release as previously directed.
- 6) Inspect the lifter for any stress damage, and repair or replace components as necessary to successfully pass the test.
- 7) Prepare a written report of the test and keep it on file.



Take precautions in case load should fall during test.



Never use lifter that has failed test.

1..... An equivalent simulation may also be used. Contact WPG for more information.

2..... A “qualified person” has successfully demonstrated the ability to solve problems relating to the subject matter and work, either by possessing a recognized degree in an applicable field or a certificate of professional standing, or by possessing extensive knowledge, training and experience.

MAINTENANCE

Note: Refer to [SERVICE MANUAL #36112](#) when applicable.

VACUUM PAD MAINTENANCE

Pad-to-Load Friction Coefficient

The friction coefficient represents the lifter's ability to resist load slippage. The Maximum Load Capacity assumes a friction coefficient of 1, based on testing of clean, new, standard rubber vacuum pads on clean, dry, regular glass. **If the lifter is used under other conditions, a qualified person must first determine the effective lifting capacity.**¹

Long-term exposure to heat, chemicals or UV light can reduce the friction coefficient of vacuum pads. Replace pads and sealing rings or replaceable inserts every 2 years or more often when necessary.

Pad Inspection

Inspect each vacuum pad (fig. 1A) according to the "INSPECTION SCHEDULE" and correct the following faults before using the lifter (see "REPLACEMENT PARTS", when applicable):

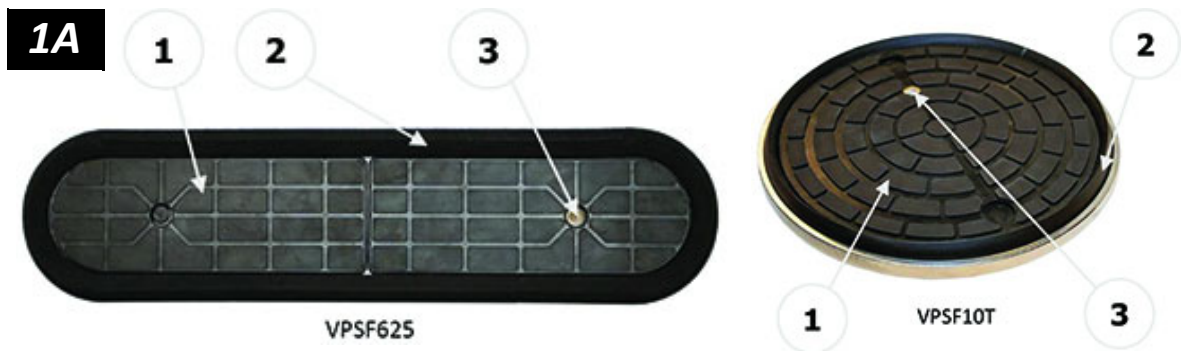

- Contaminates on the face (item 1 in fig. 1A) or sealing edges (item 2 in fig. 1A).
- Filter screen (item 3 in fig. 1A) missing from face.
- Nicks, cuts, deformation or abrasions in sealing edges.

! Replace any sealing ring or pad insert that has damaged sealing edges (see "TO REPLACE SEALING RING IN VPFS10T PADS" or "TO REPLACE PAD INSERTS IN VPFS625 PADS", where applicable).

1..... A "qualified person" has successfully demonstrated the ability to solve problems relating to the subject matter and work, either by possessing a recognized degree in an applicable field or a certificate of professional standing, or by possessing extensive knowledge, training and experience.

MAINTENANCE

Pad Cleaning



- 1) Regularly clean the face of each vacuum pad (fig. 1A), using soapy water or other mild cleansers to remove oil, dust and other contaminants.

Solvents, petroleum-based products (including kerosene, gasoline and diesel fuel) or any other harsh chemicals can damage pads.



Never use harsh chemicals on vacuum pad.

Many rubber conditioners can leave a hazardous film on pads.



Never use rubber conditioners on vacuum pad.

- 2) Prevent liquid from entering the vacuum system through the suction hole on the pad face.
- 3) Wipe the pad face clean, using a clean sponge or lint-free cloth to apply the cleanser.¹
- 4) Allow the pad to dry completely before using the lifter.

1..... A brush with bristles *that do not harm rubber* can help remove contaminants clinging to sealing edges. If these cleaning methods are not successful, contact WPG or an authorized dealer for assistance.

MAINTENANCE

TO REPLACE SEALING RING IN VPFS10T PADS

If the lifter has VPFS10T vacuum pads, replace sealing rings (**#49724RT** or **#49724TT**) as follows:

- 1) Remove the old sealing ring (fig. 1A).

Note: Make sure the entire vacuum pad is clean, including the mounting groove.

- 2) Place the inside edge of a new sealing ring against the inside edge of the mounting groove (fig. 2A).

- 3) Push the sealing ring into the mounting groove, beginning in 4 locations as shown circled in fig. 3A.

- 4) Push gently and firmly on the outside edge of the sealing ring until the flat side fits flush against the bottom of the mounting groove (fig. 4A). A pad ring installation tool (circled in fig. 4A) makes this step easier (see “REPLACEMENT PARTS”).

- 5) Make sure the sealing ring seats securely in the mounting groove, all the way around the vacuum pad (fig. 5A).

1A



2A



3A

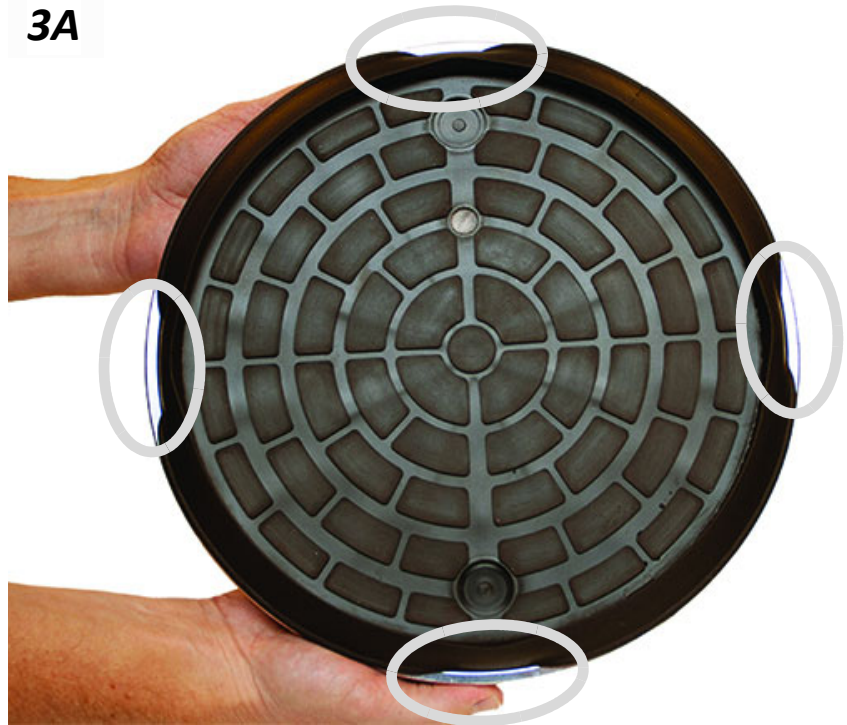

4A



5A



Note: If any part of the sealing ring comes out of the mounting groove, inspect the sealing ring for damage and reinstall an undamaged sealing ring.

REPLACEMENT PARTS

Stock No.	Description	Qty.
95857	Control Handle Extensions Kit	1
93012	Pad Shutoff Valve	10 / 14
65443	Vacuum Hose – 3/8" ID x 5/8" OD – Clear	*
65440	Vacuum Hose – 0.245" ID x 3/8" OD – Red	*
65436	Pressure Hose – 1/4" ID x 1/2" OD	*
65301	Foam – Handle Grip	*
65014	Pad Spring – Wave Type (for HV11 pads)	10 / 14
65010	Pad Spring – Coil Type (for VPFS10T pads)	10 / 14
53122	Pad Fitting – Elbow – 5/32" ID	10 / 14
49724TT	Sealing Ring for VPFS10T Pad – Closed Cell Foam	10 / 14
49724RT	Sealing Ring for VPFS10T Pad – Heat-Resistant Rubber	10 / 14
49672FT	Vacuum Pad – Model VPFS10T / 10" [25 cm] Diameter – w/Replaceable Sealing Ring	10 / 14
49605T	Vacuum Pad – Model HV11 / 10" [25 cm] Diameter – Lipped (option)	10 / 14
49190	End Plug – 2-1/2" x 3-1/2" x 1/4" Tubing Size	8
49170	End Plug – 3" x 3" x 3/16" Tubing Size	2
36112	Service Manual – Compressed Air Power System	1
29353	Pad Cover	10 / 14
20050	Pad Ring Installation Tool	1
16042	Quick Connect – 1/4 MNPT – Male End	1
16040	Quick Connect – 1/4 FNPT – Female End	1
15632	Pad Filter Screen – Small (for VPFS10T pads)	10 / 14
15630	Pad Filter Screen – Large (for HV11 pads)	10 / 14
10900	Shoulder Bolt – Socket Head – 5/16" x 1/2" x 1/4-20 Thread (for mounting pads)	60 / 84

* Length as required; sold by the inch (approx 2.5 cm).

See **SERVICE MANUAL #36112** for additional parts.

**SERVICE ONLY WITH IDENTICAL REPLACEMENT PARTS,
AVAILABLE AT WPG.COM OR THROUGH AN AUTHORIZED WPG DEALER**

REGISTRATION AND LIMITED WARRANTY

TO REGISTER THIS WPG PRODUCT

Go to the [PRODUCT REGISTRATION](#) page at [wpg.com](#) and complete the form. Registration keeps you advised of important updates and notifications, and simplifies inquiries to WPG regarding your product. Registration is **not** required to activate your Limited Warranty (see next section).

ABOUT THE LIMITED WARRANTY



Note: Read the [WARRANTY RETURN FORM](#) at [wpg.com](#) for important details about the Limited Warranty.

Wood's Powr-Grip® (WPG) products are warranted to be free from defects in manufacturing and materials for 1 year from the date of purchase.

If a problem develops during the warranty period, follow the instructions below to obtain warranty service. If inspection shows that the product has a defect, WPG will repair or replace the product without charge.



Obtaining Warranty Service or Repair Service

For customers in the U.S. and Canada: Go to the [EXCHANGES, REPAIRS, & WARRANTIES](#) page at [wpg.com](#) and click the applicable link. Alternatively, you may contact the WPG Technical Service Department (see contact information at right).

For customers in all other localities: Contact the WPG Technical Service Department (see contact information at right) or your dealer for assistance.

Address:
Wood's Powr-Grip Co., Inc.
908 West Main St.
Laurel, MT 59044 USA
Email:
contactus@wpg.com
Phone:
800-548-7341 or 406-628-8231

KEEP FOR FUTURE REFERENCE

ENGINEERING DRAWINGS

 INTENDED FOR USE BY QUALIFIED SERVICE
PERSONNEL • READ AND UNDERSTAND BEFORE
ROUTING, WIRING AND/OR ASSEMBLING



908 W. Main • P.O. Box 368
Laurel, MT USA 59044
800-548-7341 • 406-628-8231
www.WPG.com

**POWER TILTER 1500,
AIR POWERED**

Model numbers: PT1010TAIR, PT1010TAIRO, PT1410TAIRO

M:ENGINSTD08855-PT10(ECKN1734)		855-W01 [W01]	
TYPE: STANDARD	DIRECTORY: FILE [SHEET]:		
THIS DRAWING IS THE PROPERTY OF WOOD'S POWR-GRIP CO., INC. LAUREL, MONTANA U.S.A. IT IS LOANED WITH THE UNDERSTANDING THAT NEITHER IT NOR ANY INFORMATION CONTAINED THEREIN WILL BE COPIED, PUBLISHED OR TRANSMITTED TO OTHERS WITHOUT EXPRESS WRITTEN PERMISSION.			
1500# POWER TILTER		N/A	
PNEUMATIC HOSE ROUTING DIAGRAM		D855-W01 [W01]	
SIZE: A NONE	REV: 1	ECN NUMBER: 1734	DATE: 03/10/2006
BY: LER			

ALL DIMENSIONS ARE IN INCHES (mm) UNLESS NOTED OR LABELED OTHERWISE.	
TOLERANCES:	
DECIMAL FRACTIONAL ANGULAR	
X.XX ±N/A XIXX ±N/A X ° ±N/A	
X.XXX ±N/A	
DO NOT SCALE DRAWING	
DRAWN: L. RENNER	DATE: 03/14/2003
CHECKED: <i>OR</i>	1-31-07
APPROVED: <i>DM</i>	1-31-07

- NOTES:
- 1) THICK LINES REPRESENT 3/8" I.D. HOSES.
 - 2) THIN LINES REPRESENT 1/4" I.D. HOSES.

